



FLEX HEADBOARD



ASSEMBLY INSTRUCTIONS

DUX, DUXIANA and DUX Pascal-systems are registered
trademark owed by Dux Design AB 2012.
Printed 2021.02.01

dux.com



HARDWARE

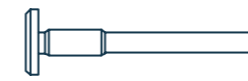

×2 Bolts



×2 Square washers

×2 Nuts



×1 Screws



×2 Washers

TOOLS NEEDED

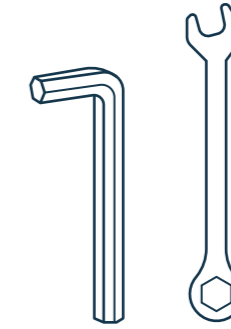

Allen key 5mm
(included)

Spanner 13mm or
adjustable wrench
(not included)

ASSEMBLING

I. MOUNT THE BARS ON THE BED

Mount the two bars from the frame on the bed using two bolts, washers and nuts.

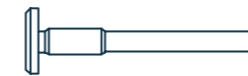

×2 Bolts



×2 Square washers



×2 Nuts

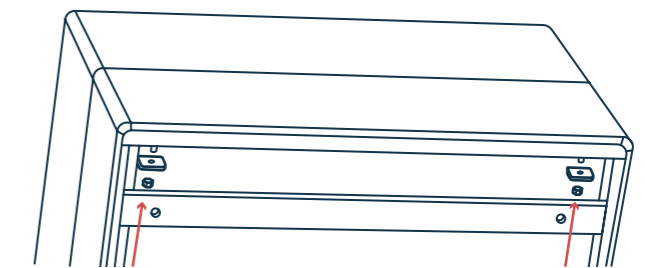
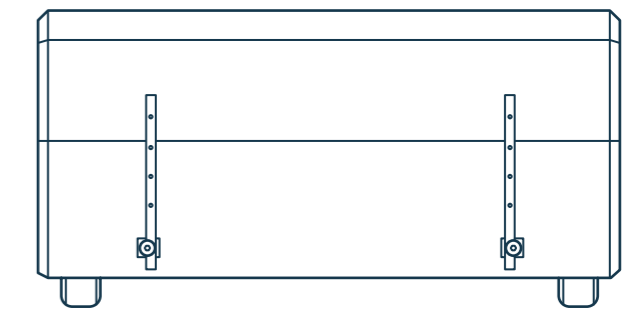

II. PUT THE HEADBOARD IN PLACE

Put the headboard in place and tighten the screws in the desired position.



×1 Screws



×2 Washers

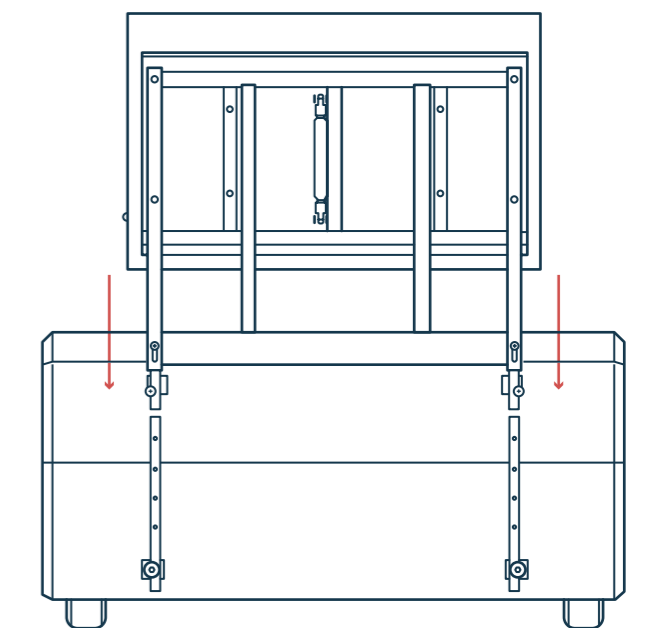

III. FINE ADJUSTMENT

There is a possibility to make a fine adjustment of the headboard height.

Be sure to fasten the screws after adjusting.

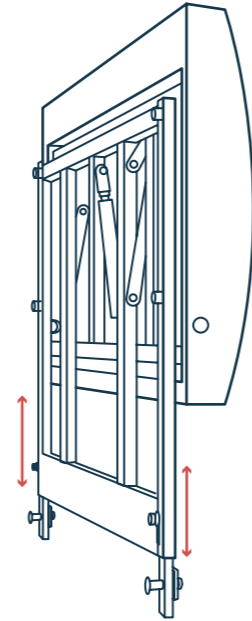

IV. ADJUST THE ANGLE

Press the button to adjust the angle of the back cushion.

